



Green Mountain BOILERS

US Trade Price Book - 2026

Effective 2/2/26



As rugged as the outdoors...
for dependable comfort every day

www.greenmountainboilers.com

ECR international

Manufactured by:
ECR International Inc.
2260 Dwyer Avenue, Utica, NY 13501
Tel. 800 325 5479
www.ecrinternational.com
PN 240011133 REV. W [12/19/2025]



CUSTOMER SUPPORT TEAM

CUSTOMER SERVICE:

Phone: (800) 325-5479 option #2
Fax: (315) 724-9319
Email Purchase Orders: ecrorderentry@ecrinternational.com
Email Inquiries: customerservice@ecrinternational.com

TECHNICAL SUPPORT:

Phone: (800) 253-7900
Fax: (866) 432-7329
Email: technical.support@ecrinternational.com

MARKETING SUPPORT:

Phone: (800) 325-5479
Fax: (315) 733-1759
E-mail: marketing@ecrinternational.com

WWW.ECRCUSTOMERPORTAL.COM

Your On-line Access to:

- Order Status
- Invoices
- Statements
- RMA
- Serial Number Look-Up
- Literature

TABLE OF CONTENTS

Condensing Natural / LP Boilers		4-5
GMHB/GMCB	Stainless Steel Combi & Heating Boilers (122-227 MBH)	4
Venting		6-9
VENTING	Coaxial, Twin Pipe & CPVC Venting for Condensing Boilers	6
Natural / LP Boilers		10-15
GMGW	Cast-Iron Chimney Vented Boilers (59-299 MBH)	10
GMPVB	Cast-Iron Induced Draft Chimney/Side Wall Vented Boilers (42-187 MBH)	12
GMGS	Cast-Iron Steam Boilers (75-299 MBH)	14
Oil Boilers		16-19
GMOW	Cast-Iron Chimney Vented Boilers (119-259 MBH)	16
GMSBO	Cast-Iron Steam Boilers (119-210 MBH)	18
Indirect Tanks		20-21
H2O GL	Single Coil Glass Lined Indirect Water Heaters (40-106 GALS)	20
Terms & Conditions of Sale		22
Shipping & Delivery Policy		23
RMA Policy		24



GMHB / GMCB Stainless Steel Combi & Heating Boilers

- MBH Input 122 - 227 (CH) / 147 - 200 (DHW)
- 95% AFUE - ENERGY STAR® Certified
- Up to 6.25:1 Turndown Ratio
- 3.4 gpm DHW (GMCB-150) @ 70°F Rise
4.9 gpm DHW (GMCB-200) @ 70°F Rise
- Stainless Steel Primary Heat Exchanger



General Information (See IOM for Complete Instructions)					
Model	GMHB-125	GMCB-150	GMHB-160	GMCB-200	GMHB-227
Water Return/Supply	1" NPT		1" NPT		1 1/4" NPT
Gas	3/4" NPT		3/4" NPT		3/4" NPT
Condensate Trap	3/4" NPT		3/4" NPT		3/4" NPT
DHW Outlet (125 Optional)	3/4" NPT		3/4" NPT		NA
DHW (Cold Water) Inlet	3/4" NPT		3/4" NPT		NA
Electrical	120 Volts AC, 60 hertz, 1 phase, less than 12 amps (15 amp circuit recommended)				
Water Content (Gallons)	1		1 1/4		1 1/4
Dimensions	A-Height	30"		30"	
	B-Width	17 3/4"		17 3/4"	
	C-Depth	14"		23"	

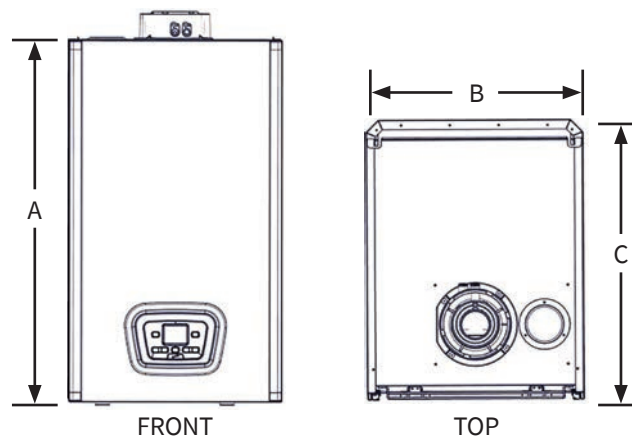

GMHB/GMCB - Stainless Steel Combi & Heating Boilers













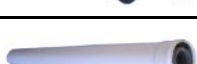

Model	Item Number	Type	Input MBH CH/DHW	AHRI Net MBH	Fuel	AFUE%	Pump	Shp. Wgt. lbs	Trade Price
GMHB125	ECR112203800104	HEATING	126	97	NAT/LP	95	LESS	102	\$3,904
GMHB165	ECR116003800104	HEATING	164	129	NAT/LP	95	LESS	125	\$4,643
GMHB227	ECR122703800104	HEATING	227	183	NAT/LP	95	LESS	120	\$9,120
GMCB150	ECR114703800104	COMBI	126/153	97	NAT/LP	95	LESS	103	\$4,201
GMCB205	ECR120003800104	COMBI	164/205	129	NAT/LP	95	LESS	125	\$4,863

While Supplies Last

















GMHB/GMCB (Use Parts Multiplier for All of the Following)

Model	Item Number	Description	Trade Price
GMHB/CB	BD710487302V	OUTSIDE AIR SENSOR	\$57
GMHB/CB	550003189	DHW SENSOR KIT	\$124
GMHB/CB	550003332	CSD-1 KIT (INCLUDES HIGH LIMIT AND MANUAL REST LWCO)	\$795
GMHB125	550003506	GMHB125/GMCB150 NATURAL GAS TO LP GAS CONVERSION KIT	\$83
GMHB160	550003507	GMHB160 NATURAL GAS TO LP GAS CONVERSION KIT	\$90
GMCB200	550003546	GMCB200 NATURAL GAS TO LP GAS CONVERSION KIT	\$59
GMHB227	550003508	GMHB227 NATURAL GAS TO LP GAS CONVERSION KIT	\$201
GMHB380	550003509	GMHB380 NATURAL GAS TO LP GAS CONVERSION KIT	\$201
GMHB/CB	240010266	FLOOR STAND KIT	\$1,034
GMHB/CB	550003212	HEAT EXCHANGER CLEANING KIT	\$87



VENTING

					Coaxial Venting		
125/150	160/200	GMHB227	GMHB380	Image	Item Number	Description	Trade Price
X					KUG714059511	2"x4" (60/100mm)COAXIAL PIPE 3.28' (1m) L	\$53
X					KUG714059611	2"x4" (60/100mm)HORIZONTAL VENT TERM	\$66
X					KUG714059711	2"x4" (60/100mm)COAXIAL 90 ELBOWS	\$42
X					KUG714059811	2"x4" (60/100mm)COAXIAL 45 ELBOWS	\$42
X					KUG714135813	2"x4" (60/100mm)VERTICAL VENT TERM	\$156
	X	X			KHG714088512	3"x5" (80/125mm)COAXIAL PIPE 3.28' (1m) L	\$78
	X	X			KHG714088713	3"x5" (80/125mm)COAXIAL 90 ELBOWS	\$43
	X	X			KHG714088812	3"x5" (80/125mm)COAXIAL 45 ELBOWS	\$43
	X	X			KHG714088911	3"x5" (80/125mm)HORIZONTAL VENT TERM	\$88
	X	X			KHG714093512	3"x5" (80/125mm)VERTICAL VENT TERM	\$123
			X		KUG714133311	4"x6" (110/160mm)HORIZONTAL VENT TERM	\$324
			X		KUG714133411	4"x6" (110/160mm)VERTICAL VENT TERM	\$412
			X		KUG714133511	4"x6" (110/160mm)COAXIAL 45 ELBOWS	\$116
			X		KUG714133611	4"x6" (110/160mm)COAXIAL 90 ELBOWS	\$116
			X		KUG714133811	4"x6" (110/160mm)COAXIAL PIPE 3.28' (1m) L	\$159

VENTING

					Twin Pipe Polypropylene Venting			
125/150	160/200	GMHB227	GMHB380	Image	Item Number	Description	Trade Price	
X					KHG714059113	TO CONVERT FROM CONCENTRIC TO 3" TWIN PIPE POLYPROPYLENE	\$23	
X	X	X			550003416	3" (80mm)VENTING CLAMP SINGLE WALL	\$49	
X	X	X			550003452	3" (80mm)CLAMSHELL CLAMP (5PK)	\$48	
X	X	X			KUG714132010	3" (80mm)HORIZONTAL VENT TERM	\$26	
X	X	X			KUG714132110	3" (80mm)VERTICAL VENT TERM	\$65	
X	X	X			550003734	3" (80mm)POLYPROPYLENE 45 ELBOWS W/ CLAMP	\$20	
X	X	X			550003735	3" (80mm)POLYPROPYLENE 90 ELBOWS W/ CLAMP	\$20	
X	X	X			550003767	3" (80mm)POLYPROPYLENE PIPE 3.28' (1m) L W/ CLAMP	\$28	
	X	X			KHG714089010	TO CONVERT FROM CONCENTRIC TO 3" TWIN PIPE POLYPROPYLENE	\$53	
			X		550003453	4" (110mm)CLAMSHELL CLAMP (5PK)	\$65	
			X		BD7106314V	TO CONVERT FROM CONCENTRIC TO 4" TWIN PIPE POLYPROPYLENE	\$172	
			X		KUG714132710	4" (110mm)HORIZONTAL VENT TERM	\$167	
			X		KUG714132810	4" (110mm)VERTICAL VENT TERM	\$149	
			X		550003731	4" (110mm)POLYPROPYLENE 45 ELBOWS W/ CLAMP	\$44	
			X		550003732	4" (110mm)POLYPROPYLENE 90 ELBOWS W/ CLAMP	\$44	
			X		550003733	4" (110mm)POLYPROPYLENE PIPE 3.28' (1m) L W/ CLAMP	\$60	

VENTING

Twin Pipe CPVC Venting								
125/150	160/200	GMHB227	GMHB380		Image	Item Number	Description	Trade Price
X						550003184	TWIN PIPE ADAPTER 60MM TO CPVC 3"	\$78
	X	X				550003403	TWIN PIPE ADAPTER 80MM TO CPVC 3"	\$145

**This page is intentionally left blank,
products continue on the following page.**

GMGW Cast-Iron Chimney Vented Boilers

- MBH Input 59 - 235 (CH)
- 84% AFUE
- Dependable Cast Iron Heat Exchanger
- Internal Operating Control
- Digital temperature display and diagnostics
- Built-In Low Water Cut-Off (LWCO)
- Control monitors water temperature and delays burner start until residual heat has been transferred to the system for maximum efficiency.
- Low Profile draft hood diverter



GMGW-8D/9D

- MBH Input 262 - 299 (CH)

General Information (See IOM for Complete Instructions)							
	GMGW-060K	GMGW-095K	GMGW-120K	GMGW-150K	GMGW-175K	GMGW-205K	GMGW-235K
Water Return/Supply	1 1/4" NPT						
Gas	1/2" NPT				3/4" NPT		
Electrical	120 Volts AC, 60 hertz, 1 phase, less than 12 amps (15 amp circuit recommended)						
Water Content (Gallons)	1.9	2.3	2.8	3.2	3.7	4.1	4.6
A-Height	32 1/8"	32 1/8"	32 1/8"	32 1/8"	32 1/8"	32 1/8"	32 1/8"
B-Width	13 3/8"	13 3/8"	16 1/4"	19"	21 7/8"	27 1/2"	27 1/2"
C-Depth	27 1/4"	27 1/4"	27 1/4"	27 1/4"	27 1/4"	27 3/4"	27 3/4"

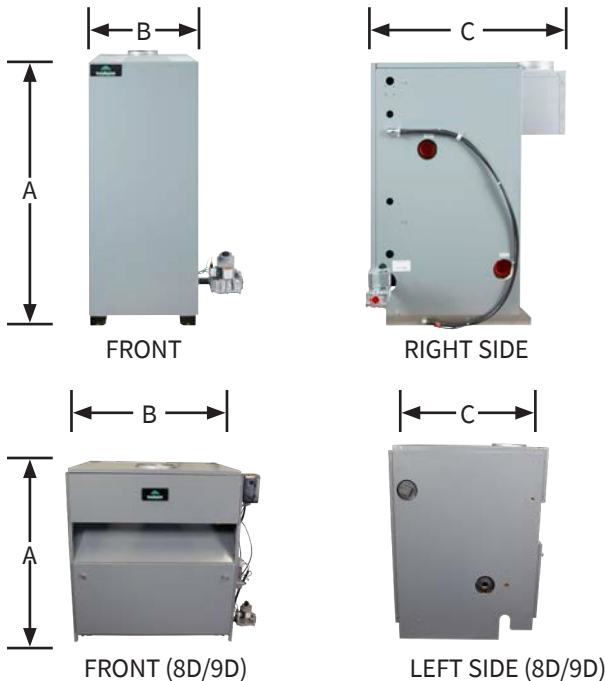

Model	GMGW-8D	GMGW-9D
Water Return/Supply	1 1/4" NPT	
Gas	1/2" NPT	
Electrical	120 Volts AC, 60 hertz, 1 phase, less than 12 amps (15 amp circuit recommended)	
Water Content (Gallons)	12.7	14.4
A-Height	36 3/8"	36 3/8"
B-Width	27 1/2"	30 3/4"
C-Depth	26 1/2"	26 1/2"

GMGW - Cast-Iron Chimney Vented Boilers

Model	Item Number	Fuel	Input MBH	Htg. Cap. MBH	AHRI Net MBH	AFUE%	Pump	Shp. Wgt. lbs	No. of Brns.	Trade Price
GMGW-060K	15B306003740304	NAT	59	50	43	84.0	TACO ECM	215	1	\$2,952
GMGW-095K	15B409503740304	NAT	90.8	76.3	66	84.0	TACO ECM	250	2	\$3,232
GMGW-120K	15B512003740304	NAT	120	101	88	84.0	TACO ECM	295	2	\$3,472
GMGW-150K	15B615003740304	NAT	149	125	109	84.0	TACO ECM	335	3	\$3,877
GMGW-175K	15B717503740304	NAT	175	147	128	84.0	TACO ECM	385	3	\$4,268
GMGW-205K	15B820503740304	NAT	205	172	150	84.0	TACO ECM	420	4	\$4,796
GMGW-235K	15B923503740304	NAT	235	197	172	84.0	TACO ECM	465	4	\$5,221
GMGW-8D	15C826203240404	NAT	262	221	192	84.0	TACO ECM	552	7	\$5,815
GMGW-9D	15C929903240404	NAT	299	252	219	84.0	TACO ECM	616	8	\$6,143

GMGW - LP

Note: Boilers require a natural gas to LP conversion kit (field installed). Sold Separately. See below.

GMGW - High Altitude

***Note: Boilers require a High Altitude conversion kit (field installed). Sold Separately. See Below. Item # is for 5000', consult factory for other elevations up to 10,000'.**

High Altitude - Capacity Reduces with Elevation. Refer to IOM for Actual Capacity Ratings.

GMGW (Use Parts Multiplier for All of the Following)

Model	Item Number	Description	Trade Price
GMGW-K	550003778	NATURAL GAS TO LP GAS CONVERSION KIT	\$118
GMGW-K	550003884	LP GAS TO NATURAL GAS CONVERSION KIT	\$129
GMGW-8D/9D	550004168	CONVERSION KIT NAT. TO LP GMGW-8D/9D	\$160
GMGW-K (3 Sec)	550003786	*NATURAL GAS HIGH ALTITUDE CONVERSION KIT - 5000' ELEVATION	\$81
GMGW-K (5-9 Sec)	550003781	*NATURAL GAS HIGH ALTITUDE CONVERSION KIT - 5000' ELEVATION	\$102
GMGW-K (3 Sec)	550003774	*LP GAS HIGH ALTITUDE CONVERSION KIT - 5000' ELEVATION	\$92
GMGW-K (5-9 Sec)	550003774	*LP GAS HIGH ALTITUDE CONVERSION KIT - 5000' ELEVATION	\$92
GMGW-8D/9D	14624002	FILL-TROL #110 FOR WATER BOILERS 150 MBH OR LESS	\$510
GMGW-8D/9D	14624003	FILL-TROL #111 FOR WATER BOILERS OVER 150 MBH	\$709

GMPVB Cast-Iron Induced Draft Chimney/Side Wall Vented Boilers

- MBH Input 42.5 - 187.5 (CH)
- Up to 84.4% AFUE
- Dependable Cast Iron Heat Exchanger with Cast Iron Push Nipples
- Honeywell High Limit/Electronic Ignition Control
 - Recessed under the boiler's protective jacket
 - Digital Temperature display and diagnostics
 - Plug in connection for the inducer fan
 - Plug in connection for the system pump
- Induced Draft Fan



General Information (See IOM for Complete Instructions)						
Model	GMPVB-42	GMPVB-75	GMPVB-112	GMPVB-150	GMPVB-188	
Water Return/Supply	1 1/4" NPT					
Gas	1/2" NPT					
Electrical	120 Volts AC, 60 hertz, 1 phase, less than 12 amps (15 amp circuit recommended)					
Water Content (Gallons)	1.75	3.00	4.25	5.50	6.75	
Dimensions	A-Height	29"	29"	29"	29"	
	B-Width	11"	14 1/4"	17 1/2"	20 3/4"	24"
	C-Depth	23 1/4"	23 1/4"	23 1/4"	23 1/4"	23 1/4"

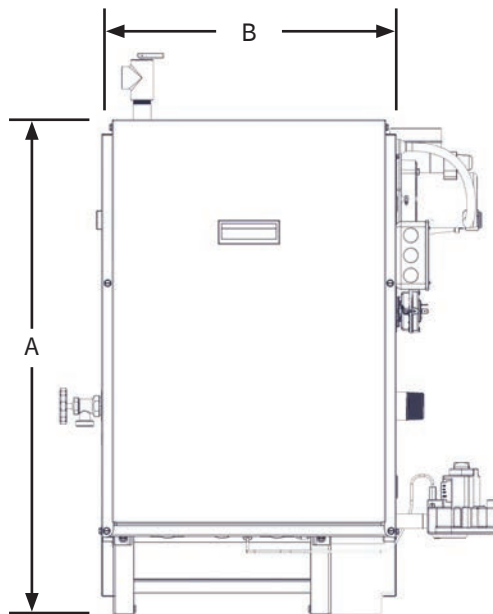

FRONT

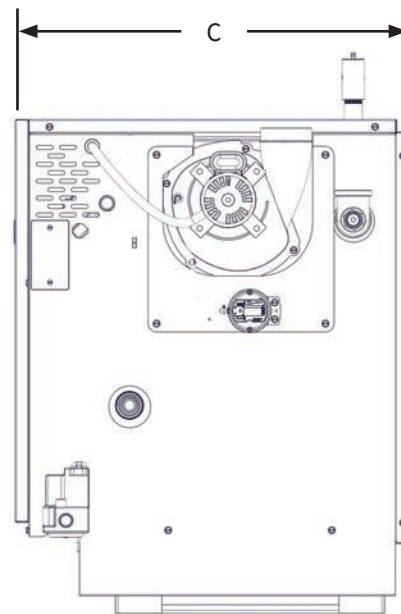

RIGHT SIDE

GMPVB - Cast-Iron Induced Draft Chimney/Side Wall Vented Boilers

Model	Item Number	Fuel	Input MBH	Htg. Cap. MBH	AHRI Net MBH	Pump	AFUE%	Shp. Wgt. Lbs	Chimney Cat. I	Side Wall Cat. III	Trade Price
GMPVB-42	FSB204203140404	NAT	42.5	36	31	TACO ECM	84.4	225	4"	3"	\$3,146
GMPVB-75	FSB307503140404	NAT	75	63	55	TACO ECM	84.0	265	4"	3"	\$3,552
GMPVB-112	FSB411203140404	NAT	112.5	95	82	TACO ECM	84.0	322	4"	3"	\$3,915
GMPVB-150	FSB515003140404	NAT	150	127	109	TACO ECM	84.0	370	4"	3"	\$4,284
GMPVB-188	FSB618703140404	NAT	187.5	158	135	TACO ECM	84.0	431	4"	4"	\$5,130

GMPVB - LP

Note: Boilers require a natural gas to LP conversion kit (field installed). Sold Separately. See below.

GMPVB - High Altitude

***Note: Boilers require a High Altitude conversion kit (field installed). Sold Separately. See Below. Item # is for 5000', consult factory for other elevations up to 10,000'.**

High Altitude - Capacity Reduces with Elevation. Refer to IOM for Actual Capacity Ratings.

GMPVB (Use Parts Multiplier for All of the Following)

Model	Item Number	Description	Trade Price
GMPVB	550002722	NATURAL TO LP CONVERSION KIT (ALL SIZES)	\$146
GMPVB	43300660	LP TO NATURAL CONVERSION KIT (ALL SIZES)	\$160
GMPVB-2	550004122	*NATURAL GAS HIGH ALTITUDE CONVERSION KIT - 5000' ELEVATION	\$146
GMPVB (3-5)	550004129	*NATURAL GAS HIGH ALTITUDE CONVERSION KIT - 5000' ELEVATION	\$146
GMPVB-6	550004136	*NATURAL GAS HIGH ALTITUDE CONVERSION KIT - 5000' ELEVATION	\$146
GMPVB-2	550004142	*LP GAS HIGH ALTITUDE CONVERSION KIT - 5000' ELEVATION	\$146
GMPVB (3-5)	550004145	*LP GAS HIGH ALTITUDE CONVERSION KIT - 5000' ELEVATION	\$146
GMPVB-6	550004149	*LP GAS HIGH ALTITUDE CONVERSION KIT - 5000' ELEVATION	\$146
GMPVB	14629010	TJERNLUND VH-1-3" SIDE WALL VENT HOOD (GMPVB-2 TO GMPVB-5)	\$404
GMPVB	14629011	TJERNLUND VH-1-4" SIDE WALL VENT HOOD (GMPVB-6)	\$480

GMGS SERIES - Cast-Iron Steam Boiler

Model	Item Number	Fuel	Input MBH	Htg. Cap. MBH	AHRI Net MBH	AHRI Net SQ. FT. Steam	AFUE%	Shp. Wgt. lbs	Trade Price
GMGS075E	16B307503700604	NAT	75	62	47	195	82.7%	297	\$3,691
GMGS112E	16B411203700604	NAT	112	91	68	283	82.0%	368	\$4,128
GMGS150E	16B515003700604	NAT	150	122	92	383	82.0%	440	\$4,611
GMGS187E	16B618703700604	NAT	187	153	115	479	82.0%	512	\$5,271
GMGS225E	16B722503700604	NAT	225	183	137	570	82.0%	584	\$5,887
GMGS262E	16B826203700604	NAT	262	214	161	670	82.0%	659	\$6,504
GMGS299E	16B929903700604	NAT	299	245	184	766	82.0%	736	\$6,927

GMGS - LP

Note: Boilers require a natural gas to LP conversion kit (field installed). Sold Separately. See below.

GMGS - High Altitude

***Note: Boilers require a High Altitude conversion kit (field installed). Sold Separately. See Below. Item # is for 5000', consult factory for other elevations up to 10,000'.**

High Altitude - Capacity Reduces with Elevation. Refer to IOM for Actual Capacity Ratings.

GMGS SERIES (Use Parts Multiplier for All of the Following)

Model	Item Number	Description	Trade Price
GMGS075E	43300723	3 SECTION NATURAL GAS TO LP GAS CONVERSION KIT	\$87
GMGS112E	43300724	4 SECTION NATURAL GAS TO LP GAS CONVERSION KIT	\$87
GMGS150E	43300725	5 SECTION NATURAL GAS TO LP GAS CONVERSION KIT	\$87
GMGS187E	43300726	6 SECTION NATURAL GAS TO LP GAS CONVERSION KIT	\$102
GMGS225E	43300727	7 SECTION NATURAL GAS TO LP GAS CONVERSION KIT	\$102
GMGS262E	43300728	8 SECTION NATURAL GAS TO LP GAS CONVERSION KIT	\$102
GMGS299E	43300729	9 SECTION NATURAL GAS TO LP GAS CONVERSION KIT	\$102
GMGS	550004368	*NATURAL GAS HIGH ALTITUDE CONVERSION KIT - 5000' ELEVATION	\$97
GMGS	550004373	*LP GAS HIGH ALTITUDE CONVERSION KIT - 5000' ELEVATION	\$97
GMGS	1630001	MCDONNELL & MILLER WF-2U-24 ELECTRONIC WATER FEEDER	\$818

GMOW Cast-Iron Chimney Vent Boilers

- MBH Input 119 - 259 (CH)
- Up to 87% AFUE
- Dependable Cast Iron Heat Exchanger with Cast Iron Push Nipples
- Hydrolevel Operating Control
 - Digital Temperature display and diagnostics
 - Adjusts water temperature based on heating system demand
 - Built-In Low Water Cut-Off (LWCO)
 - Boiler Reset
- Burner swing door for easy serviceability
- Multiple Firing Rates
- Optional tankless domestic hot water (DHW) coil



General Information (See IOM for Complete Instructions)					
GMOW	3085(T)	4100(T)	4125(T)	5160(t)	6185(T)
Water Return/Supply	1 1/2" Return NPT, 2" Supply NPT				
Oil	3/8" O.D. Copper (runs 50' or less, 1/2" O.D. Copper (runs over 50')				
Electrical	120 Volts AC, 60 hertz, 1 phase, less than 12 amps (15 amp circuit recommended)				
Water Content (Gallons)	10.5	13.5	13.5	16.5	19.5
Dimensions	A-Height	35"	35"	35"	35"
	B-Width	21 13/16"	21 13/16"	21 13/16"	21 13/16"
	C-Depth	17 7/8"	21 1/2"	21 1/2"	25 1/8"

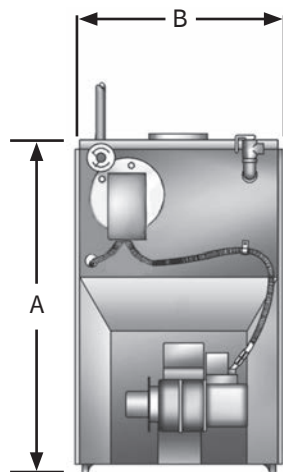

FRONT

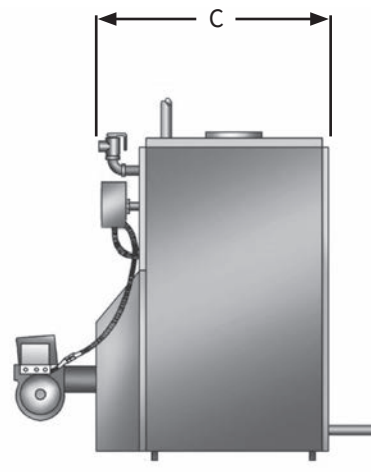

RIGHT SIDE

GMOW - Cast-Iron Chimney Vent Oil Boiler											
Model	Item Number	Type *	Input MBH	Htg. Cap. MBH	AHRI Net MBH	Burner	Pump	AFUE%	Firing Rate GPH	Shp. Wgt. Lbs	Trade Price
GMOW-3085	GMA308520240504	C.O.	119	103	90	LESS	TACO ECM	86.0%	0.85	534	\$3,618
GMOW-4125	GMA412520240504	C.O.	175	152	132	LESS	TACO ECM	86.0%	1.25	668	\$3,957
GMOW-5160	GMA516020240504	C.O.	224	195	170	LESS	TACO ECM	86.0%	1.60	781	\$4,949
GMOW-6185	GMA618520240504	C.O.	259	226	197	LESS	TACO ECM	86.0%	1.85	901	\$5,666
GMOW-3085T	GMA308522240504	T.C.	119	103	90	LESS	TACO ECM	86.0%	0.85	534	\$4,060
GMOW-4125T	GMA412522240504	T.C.	175	152	132	LESS	TACO ECM	86.0%	1.25	668	\$4,328
GMOW-5160T	GMA516022240504	T.C.	224	195	170	LESS	TACO ECM	86.0%	1.60	781	\$5,306
GMOW-6185T	GMA618522240504	T.C.	259	226	197	LESS	TACO ECM	86.0%	1.85	901	\$6,028

*TYPE (C.O. - CAST OVER) (T.C. - TANKLESS COIL)

GMOW (Use Equipment Multiplier for All of the Following)			
Model	Item Number	Description	Trade Price
GMOW	550004108	GMOW-3 BECKETT BURNER IN A BOX KIT	\$1,293
GMOW	550004109	GMOW-4 BECKETT BURNER IN A BOX KIT	\$1,293
GMOW	550004110	GMOW-5 BECKETT BURNER IN A BOX KIT	\$1,293
GMOW	550004111	GMOW-6 BECKETT BURNER IN A BOX KIT	\$1,293
GMOW	550004112	GMOW-3/4/5 REILLO BURNER IN A BOX KIT	\$1,572
GMOW	550004113	GMOW-6 REILLO BURNER IN A BOX KIT	\$1,792
GMOW	550004114	GMOW-3/4 CARLIN BURNER IN A BOX KIT	\$1,293
GMOW	550004115	GMOW-5/6 CARLIN BURNER IN A BOX KIT	\$1,293

GMSBO Cast-Iron Steam Boilers

- MBH Input 119 - 210 (CH)
- Up to 85.6% AFUE
- Dependable Cast Iron Heat Exchanger
- Honeywell Operating Control
- Burner swing door for easy serviceability
- Multiple Firing Rates
- Chimney Venting
- Optional tankless domestic hot water (DHW) coil



General Information (See IOM for Complete Instructions)		
	SBO-3	SBO-4
Return/Supply Tappings	1 1/4" Return NPT, 2" Supply NPT	
Oil	3/8" O.D. Copper (runs 50' or less, 1/2" O.D. Copper (runs over 50')	
Electrical	120 Volts AC, 60 hertz, 1 phase, less than 12 amps (15 amp circuit recommended)	
Water Content (Gallons)	12	14.87
Dimensions	A-Height	35"
	B-Width	22 1/8"
	C-Depth	19 3/4"

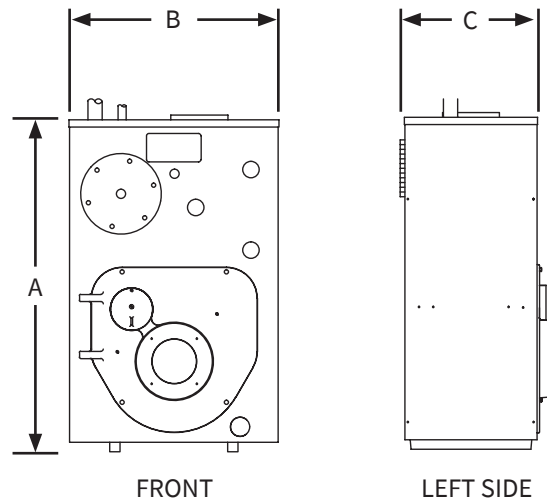

GMSBO - Cast-Iron Chimney Vent Oil Boiler Less Burner										
Model	Item Number	Input MBH	Htg. Cap. MBH	Steam Sq Ft	AHRI Net MBH	AFUE%	Burner	Firing Rate GPH	Shp. Wgt. Lbs	Trade Price
SBO-3105	SBO310521700104	147	127	396	95	85.0	LESS	1.05	538	\$4,809
SBO-4150	SBO415021700104	210	180	563	135	85.0	LESS	1.50	650	\$5,231

GMSBO (Use Equipment Multiplier for All of the Following)			
Model	Item Number	Description	Trade Price
SBO	550004158G	TANKLESS COIL WITH CONTROL	\$452
SBO-3105	550004153G	GMSBO-3 BECKETT BURNER IN A BOX KIT	\$1,293
SBO-4150	550004154G	GMSBO-4 BECKETT BURNER IN A BOX KIT	\$1,293

Please Note: Oil Fired Steam Boilers are sold less burner. Please add burner in a box kit to your order. Tankless Coil Kits are sold separately.

GMSBO (Use Parts Multiplier for All of the Following)			
Model	Item Number	Description	Trade Price
SBO	550004155	3085/3105 BECKETT RERATE KIT	\$201
SBO	550004156	4125/4150 BECKETT RERATE KIT	\$201



Conforms to UL STD 174
 Certified to CAN/CSA STD C22.2 No. 110-94

H2O GL Single Coil Glass Lined Indirect Water Heaters

- 31 - 106 Gallon Capacities
- Easy to Install
- Low Pressure Drop
- Magnesium Anode Rod (Corrosion Protection)
- Enameled Coated Steel Tank and Coil
- Minimal Standby Losses
- Flexible Scratch Resistant Jacket
- Aquastat Sensor Well
- Temperature Pressure Relief Valve



(H2O40GL Model Shown)

General Information (See IOM for Complete Instructions)					
Maximum Working Pressure: 150 psi for all Capacities					
Model	Piping Connections NPT		Dimensions		
	Domestic Water In/Out	Boiler Water In/Out	Diameter	Height	Weight
GMGL30	1"	1"	24"	33"	119 lbs
GMGL40I	1"	1"	24"	45"	180 lbs
GMGL50I	1"	1"	24"	51"	200 lbs
GMGL80I	1"	1"	30"	48"	243 lbs
GMGL105I	1"	1"	30"	62"	393 lbs

H2O GL SERIES - Single Coil Glass Lined Indirect Water Heaters (While Supplies Last)								
Model	Item Number	Storage Capacity gal	Type	Max. First Hour Rating gal/hr @ 115° F	Continuous Rating gal/hr @ 115° F	Boiler Output Req. BTU/hr	Shp. Wgt. lbs	Trade Price
GMGL40I	H2OIG40GM	42	GLASS LINED	198	162	120,000	180	\$1,713
GMGL105I	H2OIG105GM	106	GLASS LINED	270	175	220,000	393	\$4,257
H2O GL SERIES (Use Parts Multiplier for All of the Following)								
Model	Item Number	Description						Trade Price
30-105 GAL.	240010926	T & P VALVE 3/4, 100XL-8						\$76
30-105 GAL.	AQ-020.01	AQUASTAT WELL						\$53
30-105 GAL.	240013432	AQUASTAT						\$208
30-50 GAL.	240012211	PLASTIC TOP CAP						\$42
80-105 GAL.	240012239	PLASTIC TOP CAP						\$57
40-105 GAL.	240012212	PLASTIC FRONT CAP						\$9
30 GAL.	550003640	ANODE KIT MAGNESIUM (INCLUDES ANODE, GASKET & BUSHING)						\$55
40-50 GAL.	550003505	ANODE KIT MAGNESIUM (INCLUDES ANODE, GASKET & BUSHING)						\$55
80-105 GAL.	550003527	ANODE KIT MAGNESIUM (INCLUDES ANODE, GASKET & BUSHING)						\$105
40-50 GAL.	550003694	ANODE KIT ALUMINUM (INCLUDES ANODE, GASKET & BUSHING)						\$55
80-105 GAL.	550003695	ANODE KIT ALUMINUM (INCLUDES ANODE, GASKET & BUSHING)						\$105
30-50 GAL.	240012250	FLANGE CAP						\$57
80-105 GAL.	240012251	FLANGE CAP						\$22
30-50 GAL.	240012210	FLANGE GASKET						\$2
80-105 GAL.	240012238	FLANGE GASKET						\$4
40-50 GAL.	550003510	HARDWARE KIT (INCLUDES BOLTS & NUTS FOR FLANGE CAP)						\$4
80-105 GAL.	550003525	HARDWARE KIT (INCLUDES BOLTS & NUTS FOR FLANGE CAP)						\$4
H2O 30 GL	240012474	OUTSIDE TANK COVER						\$152
H2O 40 GL	240012329	OUTSIDE TANK COVER						\$154
H2O 50 GL	240012330	OUTSIDE TANK COVER						\$166
H2O 80 GL	240012331	OUTSIDE TANK COVER						\$116
H2O 105 GL	240012332	OUTSIDE TANK COVER						\$203
30-50 GAL.	240012483	TEMPERATURE GAUGE						\$23

TERMS & CONDITIONS OF SALE - GENERAL TERMS

PRICES & SPECIFICATIONS: All pricing and specifications subject to change without notice. The prices herein supersede all prior quotations.

ORDERS: Orders will be accepted based on prices in effect at the time the order is received. No order or contract will become an obligation on our part until accepted by the General Sales Department. ECR International shall not be liable for any delay or failure in the delivery or shipment of goods due to any cause or causes beyond its control.

TAXES: Add to the prices and terms quoted any manufacturers' or sales tax payable on the transaction under any effective statute.

SHIPMENTS

TRUCKLOADS: \$60,000 Net Order Value - Freight Prepaid. Indirect Water Heaters and Commercial Boiler lines can be added to any residential order for freight purposes. Authorized Distributors can combine Argo, Airco, Dunkirk, EMI, Olsen, Pennco, Utica Boilers and Utica Heating on one purchase order to earn free freight.

Stop off charges of \$200 will apply to stop off locations within 100 miles of the final destination. Please call for pricing for stop off special handling for a location further than 100 miles or for special handling pricing for services such as lift gate, unloading assistance, etc.

LESS THAN TRUCKLOAD SHIPMENT: F.O.B. ECR INTERNATIONAL - FACTORY OR WAREHOUSE

See Shipping and Delivery Policy for full details.

SALES ORDER INFORMATION CHECK LIST

The following information must be included on equipment or parts orders to insure proper shipment & invoicing:

- | | |
|--|--|
| 1) Purchase Order Number | 7) Pricing |
| 2) Bill to Address | 8) Product Description (Model, Size, etc.) |
| 3) Ship to Address | 9) Fuel Type (Oil, Natural Gas, Propane) |
| 4) Method of Shipment (trailer load, UPS) | 10) Electrical (Operating Voltage, Cycles, Phases, etc.) |
| 5) Requested Ship Date | 11) Non-Standard Equipment (Indicate "Optional" when substituted for standard equipment at extra cost listed. Indicate added to standard equipment.) |
| 6) Special Instructions ("Carrier to call...") | 12) Kits or Parts (Orders for kits or parts must indicate equipment size and series.) |

Send orders to:

E-mail: ecrorderentry@ecrinternational.com

Fax: (315) 724-9319

Please note the following Remit to Address:

ECR International, Inc.

P.O. Box 8000 Department 039

Buffalo, NY 14267

SHIPPING AND DELIVERY POLICY

Shipping and Delivery Policy	
Order Type / Value*	Freight Charges*
All UPS, Fed, Ex, DHL, etc. Shipments	Freight & Handling Cost Apply
\$0.00 - \$5,000	Freight & Handling Cost Apply
\$5,001 - \$15,000	\$350
\$15,001 - \$59,999	\$300
\$60,000**	FFA

*The above freight terms apply to single purchase orders or combined purchase orders from one company with one stop totaling the above reference tiers. Additional stops will incur additional charges. Pooling from multiple companies is not allowed under this freight program.

**Orders of \$60,000 or more from one company with multiple stops will incur a \$200 stop-off charge per stop after the initial stop. Each stop location must be within 100 miles of the initial stop or additional charges will apply.

Because of packaging and shipping constraints, EMI products do not qualify for this freight program unless prior approval is obtained from your Regional Sales Manager.

Except for FFA qualifying orders, the above US shipping rates apply to shipments east of the Mississippi River. If shipments are beyond that area actual freight rates will apply.

These rates apply to destinations where no special delivery requirements are needed. Additional charges will apply when special handling and delivery is incurred. Pre-shipment notification of any special shipping or handling provisions is required. Unless otherwise noted, all products will be shipped FOB Shipping Point and transfer of ownership and responsibility is assumed by the customer for all loss or damage. ECR International will not be held liable for any damage, loss or costs which occur due to shipping delay. ECR retains the right to change or alter this program without notice and without penalty.

Family bundling is encouraged; boilers, furnaces, A/C, and controls can be combined to achieve freight tiers.

If you have any questions, please contact your ECR representative or ECR Regional Manager.

U.S. DISTRIBUTOR - RETURN MATERIAL POLICY (RMA)

Prior Approval Required - All returns for exchange, credit, repair service or warranty claim must be approved by ECR International and require an RMA number prior to return of the material. A request must be completed via the online web portal. Please log on to www.ecrcustomerportal.com to complete your request for return. If you do not already have access to the customer web portal, please contact ECR International Customer Service at 1-800-325-5479 to be set-up.

Eligibility – An RMA Request must be received within 60 days from the date of invoice for returns of New & Unused product in original packaging. A restocking fee of 15% will be charged for all new and unused returns that are approved for return. Special Order Products (items not offered as standard in ECR International trade price book) are not eligible for return as new and unused product. Request for Warranty Returns must be made within the period covered by the warranty and must fall under the terms and conditions specified in the warranty.

Repair Service - Request for repair or rework of product damaged by customer is classified as Repair Service. Repair Service is billed at \$75.00 per hour for labor and net price for parts used in repair/rework. ECR International's Return Material (RM) department will evaluate the items returned for repair service. The customer will receive an estimate for the dollar amount, determined by ECR International's RM department, required to complete the repairs requested. A Purchase Order (PO) from the customer for that amount will be required before any work is performed.

RMA Expiration Parts - Once the RMA number is issued, the product must be returned within 60 days of the RMA date, or the RMA will be canceled. Products approved for return that are received after 60 days from the RMA date will not be accepted.

Shipping & Packaging - All returns must have a valid RMA number clearly displayed on the exterior of the package or the package will not be accepted. All returns of new and unused product must be in the original packaging. All returns must be shipped prepaid by the customer unless otherwise directed by ECR as indicated on the RMA Verification. Ship all approved return material to the facility indicated on the approved RMA Request by the date indicated.

Replacement Product - If replacement product is desired it must be indicated on the RMA Request. A PO# is required for the replacement shipment and must be indicated on the RMA Request. All replacement products will be invoiced at the time of shipment. ECR will pay the ground freight for all warranty replacements.

Application of Credit - Credit for returned product will be applied to the customer's account (less restocking fees for New and Unused returns) only after confirmation of receipt by ECR and inspection of the product. Issuance of a credit for a partial return of product does not relieve the customer from the obligation to remit payment for the merchandise not returned in accordance with the payment terms referenced on the customer's invoice(s). Customer will have the option to have any product that is denied for credit returned at their expense.

Returning Installed Finished Goods (Complete boilers, furnaces, A/C units etc.)

- Equipment that is already installed should be repaired not replaced. Exceptions: leaking cast iron boilers in their first year or leaking water tanks. Leaking drain valves on water tanks are replaceable, make sure the leak is not on the valve. Tanks returned with the only leak being on the valve will be denied.
- Cast iron blocks (not complete boilers) older than one year and Indirect tanks that are leaking do not require prior approval. Simply type "Leaking" into the Authorization field and it will be accepted. Complete Cast iron boilers within their first year will still require prior authorization for full boiler replacement.
- Water leaks on copper and condensing boilers are repairable and will require prior authorization for any reason for removal.
- To guarantee credit, if a situation arises where equipment does need to be replaced, **prior authorization** from ECR is required. This will ensure that ECR has visibility to the problem and has had an opportunity to correct it prior to removal. *All equipment considered for removal should first be brought to the attention of Technical Support at 1-800-253-7900.*
- If approved, an authorization number will be given that will need to be entered in the RMA on the Customer Portal.
- For equipment that is removed from service without prior authorization by ECR, contact Customer Service. They will evaluate the circumstance and can issue a conditional RMA. The equipment will be tested in our lab to determine if removal was warranted and if credit will be given.

RMA Expiration Equipment - Once the RMA number is issued, the product must be returned within 30 days of the RMA date, or the RMA will be canceled. Products approved for return that are received after 30 days from the RMA date will not be accepted.